

IF602P-IF603P-IF604P

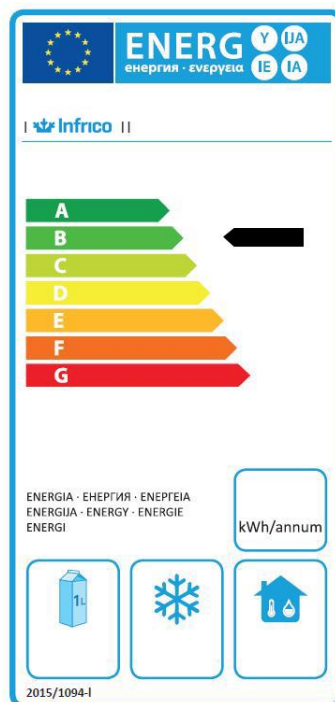

BENEFICIOS / BENEFITS / AVANTAGES

- ✓ Mejora de la clasificación energética, debido al uso del refrigerante R-290 y de la circulación optimizada del aire para una mejor uniformidad de temperatura en el interior.
Mayor precisión en el control de la temperatura.
Nuevo diseño de puertas con tirador de doble agarre.
Sistema de refrigeración Monoblock.
Encimera con peto sanitario de 100 mm de altura.
- ✓ Improved energy classification due to the use of R-290 refrigerant and optimized air circulation for better interior temperature uniformity.
Greater precision in temperature control.
New door design with double grip handle.
Monoblock cooling system.
Countertop with sanitary 100 mm high splashback.
- ✓ Classification énergétique améliorée grâce à l'utilisation du réfrigérant R-290 et à une circulation d'air optimisée pour une meilleure uniformité de la température à l'intérieur.
Plus grande précision dans le contrôle de la température.
Nouveau design de porte avec poignée à double poignée.
Système de refroidissement monobloc.
Plan de travail avec bavette sanitaire de 100 mm de haut.



IF603P

IF602P-IF603P-IF604P

IF602P-IF603P-IF604P

Rango Tª / Operating temp / Régime de Température	-2°C / +8°C		
Clase climática / Climate class / Classe climatique	4 (30°C, 55%HR)		
Capacidad / Capacity / Capacité (l)	345-535-730		
Medidas exteriores LxFxA / Overall dimensions LxDxH / Dimensions extérieures LxIxH (mm)	1.468 x 600 x 1.050 1.960 x 600 x 1.050 2.452 x 600 x 1.050		
Características constructivas / Cabinet Construction / Caractéristiques du fabricant			
Material exterior / Exterior Material / Matériau extérieur	Acero inoxidable AISI 430	AISI 430 Stainless Steel	Acier Inoxydable AISI 430
Material respaldo / Back Material / Matériau à l'arrière	Acero galvanizado	Galvanized steel	Acier galvanisée
Material interior / Interior Material / Matériau intérieur	Acero inoxidable AISI 430	AISI 430 Stainless Steel	Acier Inoxydable AISI 430
Material encimera / Worktop Material / Matériau du plan de travail	Acero inoxidable AISI 304	AISI 304 Stainless Steel	Acier Inoxydable AISI 304
Características del interior / Interior Construction / Caractéristiques intérieures	Uniones de amplio radio.	Rounded interior corner	Intérieur bords arrondis à large rayon
Desagüe / Drain / Vidange	✓		
Iluminación LED / LED lighting Eclairage LED	✗		
Tipo aislamiento / Insulation / Type d'isolation	Poliuretano con densidad 40kg/m3, libre CFCs, cero ODP y bajo GWP	Polyurethane with high density 40kg/m3, CFCs free, zero ODP and low GWP	Isolation en polyuréthane injecté à haute pression de CFC avec une densité de 40kg/m ³ , Zéro ODP et GWP faible.
Espesor aislamiento / Insulation thickness / Epaisseur de l'isolation (mm)	70		
Espumante / Blowing Agent / Mousse	HFO		
Dotación / Features / Equipement de série			
Nº puertas / Doors / Nombre de portes	2 3 4		
Tipo de puerta / Door construction / Type de porte	-	-	-
Cerradura / Door lock / Serrure	-		
Marcos puerta calefactados / Door frame heaters / Cordon chauffant encadrement porte	✗		
Nº total estantes / Shelving / Nombre d'étagères	4 6 8		
Dimensiones estantes Lx F / Shelves dimensions LxD / Dimensions des étagères L x l(mm)	-		

Tipo de patas, ruedas / Legs, casters / Type de pieds, roulettes	Patas en acero inoxidable, regulables en altura 130-180mm	Stainless steel legs, height adjustable from 130-180mm	Pieds en acier inoxydable, hauteur réglable 130-180mm
Características frigoríficas / Refrigeration / Caractéristiques du froid			
Controlador / Thermostat / Thermostat	-	-	-
Sistema de frío / Refrigeration system / Système de froid	Monoblock		
Desescarche / Defrost / Dégivrage	Parada de compresor	Compressor off	Arrêt du compresseur
Dispositivo expansión / Expansion Device / Détendeur	Capilar	Capillary	Capillaire
Ventiladores electrónicos / Electronic fans / Ventilateurs électroniques	X		
Sistema de condensación / Condensation / Système de condensation	Forzada	Forced-air	Forcé
Sistema de evaporación / Evaporation / Système d'évaporation	Automática	Automatic	Automatique
Datos técnicos / Technical Features / Informations techniques			
Refrigerante / Refrigerant / Gaz réfrigérant	R290		
Carga / Ref amount / Charge de gaz (gr)	110		
Tensión/fases/frecuencia / Power Supply / Tension /phase/Fréquence	230V / 1 / 50 Hz		
Potencia frigorífica / Refrigeration Capacity / Puissance frigorifique (W)	370 690		
Potencia / Power / Puissance (W)	264 435		
Intensidad / Amps / Intensité (A)	2,6 2,8		
Consumo / Energy Consumption / Consommation (kWh/24h)	2,04 2,4 2,73		
Clasificación Energética / Energy Class / Classification énergétique	B		
Paletización / Crating / Palettisation			
Medidas paletización LxFxA / Crated dimensions / Dimensions palettisation L x l x H (mm)	1.510 x 660 x 990 2.010 x 660 x 1.140 2.500 x 710 x 1.180		
Volumen bruto / Crated volume / Volume brut (l)	925 1235 1545		
Peso neto / Net Weight / Poids net (kg)	103 166 217		
Peso paletización / Crated Weight / Poids palettisation (kg)	113 180 217		
Opcionales / Options			
	Parrilla	Wire shelf	Grille métallique

www.infrico.com

info@infrico.com

Ctra. de Aguilar A-318 por Moriles Km. 15,5 – A-3132 - 14900, Lucena (Córdoba)

Características técnicas y constructivas sujetas a variación sin previo aviso

We reserve the right to change specifications without prior notice

Les caractéristiques techniques et la conception peuvent être sujettes à modifications, sans préavis



IF602P-IF603P-IF604P

ALZADO/ ELEVATION/ VUE LATÉRAL

PLANTA/PLAN VIEW/DESSUS/VUE DE PROFIL

PERFIL / RIGHT VIEW / VUE EN PLAN

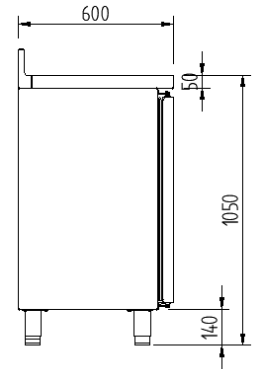
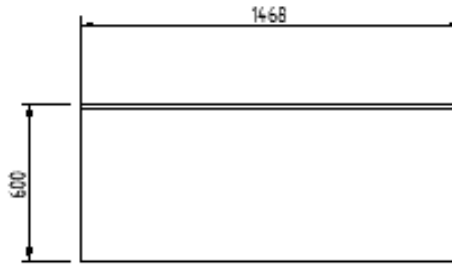
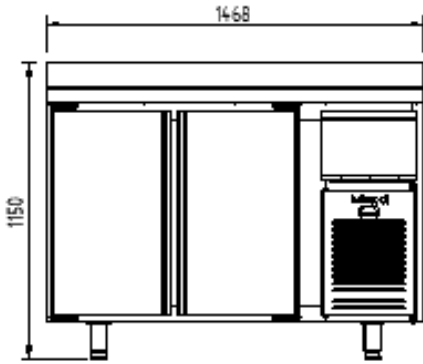

IF602P

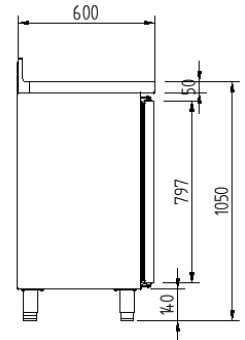
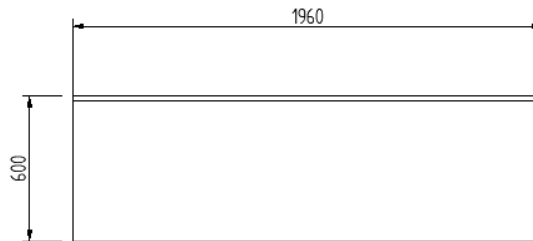
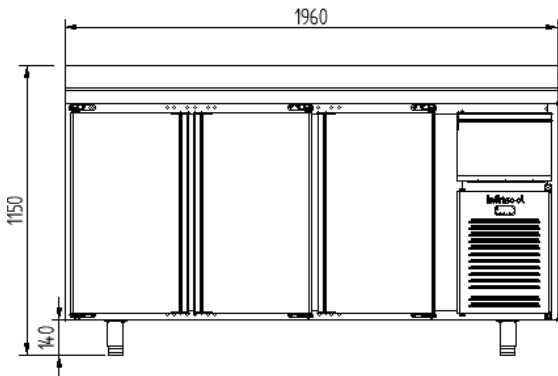

IF603P

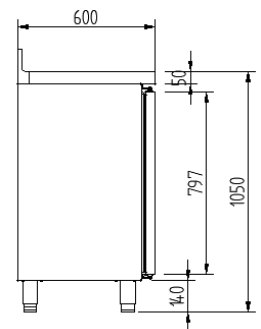
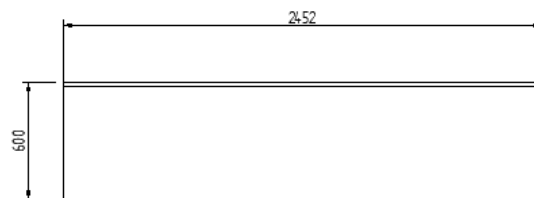
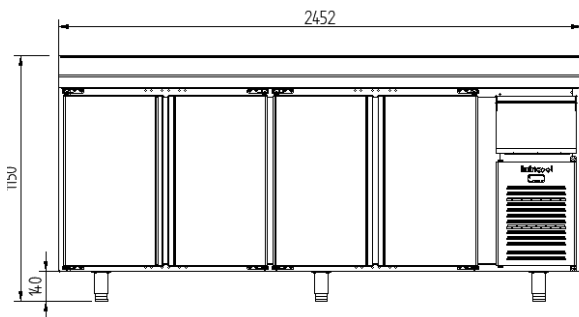

IF604P

www.infrico.com
info@infrico.com

Ctra. de Aguilar A-318 por Moriles Km. 15,5 - A-3132 - 14900, Lucena (Córdoba)

Características técnicas y constructivas sujetas a variación sin previo aviso
We reserve the right to change specifications without prior notice

Les caractéristiques techniques et la conception peuvent être sujettes à modifications, sans préavis



IF602P-IF603P-IF604P

CONEXIONES / CONNECTION / CONNEXIONS

MODELOS	A (mm)	B (mm)	C (mm)	D (mm)
IF602P	63	63	542	113
IF603P	63	63	788	113
IF604P	63	63	1033	113

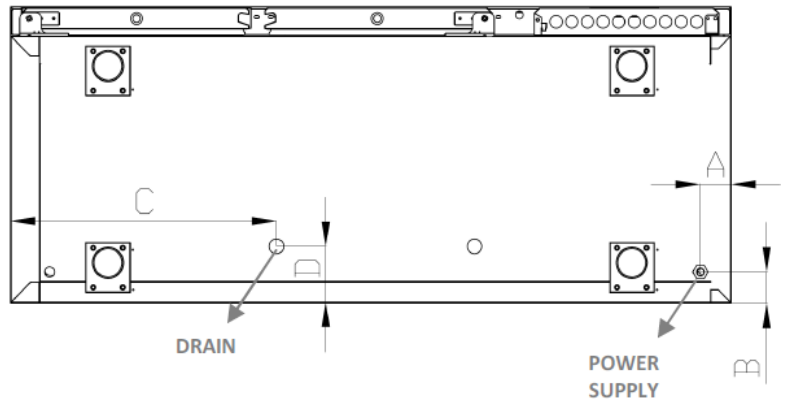

Rev: 01 Fecha/Date: 25/01/2022 FT_IF602P_00_ES_EN_FR_22_01 FT_IF603P_00_ES_EN_FR_22_01 FT_IF604P_00_ES_EN_FR_22_01

www.infrico.com
info@infrico.com

Ctra. de Aguilar A-318 por Moriles Km. 15,5 – A-3132 - 14900, Lucena (Córdoba)

Características técnicas y constructivas sujetas a variación sin previo aviso
We reserve the right to change specifications without prior notice

Les caractéristiques techniques et la conception peuvent être sujettes à modifications, sans préavis

